

SPARE PARTS LIST

01/01/00

REWIND MACHINES

MODEL(S):

WT-20

WT-15

WT-15LC

WT-15LCI

WT-25

WT-25LC

WT-25LCI

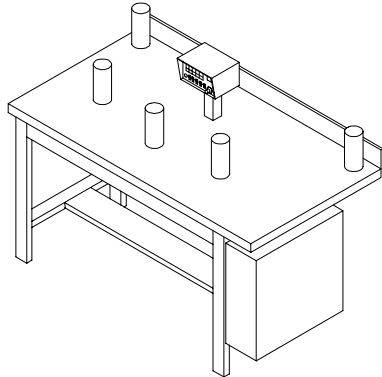
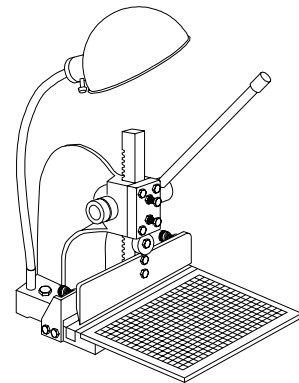

PLATE CUTTERS

MODEL(S):

WT-1

WT-2



STROBOSCOPE INSPECTION SYSTEMS

MODEL(S):

SB-10 STROBE LAMP

SB-11 STROBE LAMP

SB-20 STROBE CONTROL

SB-21 STROBE CONTROL

SB-22 STROBE CONTROL

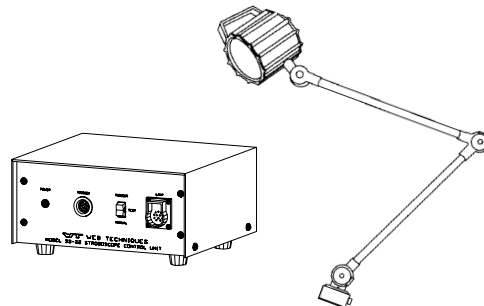

OPTIONAL EQUIPMENT

◆ SLITTING ATTACHMENT ◆ SPLICING AID ◆ LABEL COUNTING SYSTEM ◆

WEB TECHNIQUES

910 Bolger Court
Fenton, MO 63026

(636) 343-0806 Fax: (636) 343-6629

TOLL FREE: 1-800-325-9777

Web Site: <http://www.webtechniquesinc.com>
e-mail: sales@webtechniquesinc.com

CAN'T FIND WHAT YOU ARE LOOKING FOR?

WEB TECHNIQUES
OFFERS A TOLL-FREE
TECHNICAL SUPPORT HOTLINE.

PLEASE CALL 1-800-325-9777.

CONSULT FACTORY FOR CURRENT PRICES.

INDEX

Rewind Machines

Coreholders & Coreholder Adapters 2,3

Electrical Components

Fuses 4
Switches 4
Pushbuttons/Contact Blocks 4-5
Relays/Relay Sockets 5
Potentiometers/Knobs 6
Lamps 6
Circuit Boards 7

Footswitch Replacement Kit 7

Miscellaneous

Tape Dispenser 7
Operator's Manual 7

Counting System

Counters 8

Miscellaneous

Replacement Counter Pkg 8
Switches 8-9
Scanners 9

Idler Rolls, Clamps, Cartridges, Bearings,
Shafts/Flanges

Idler Rolls 10
Collar Clamps 10
Cartridges 10
Bearings 10
Shafts/Flanges 10-11
Shafts 11

Motors, Motor Controls, Brake System,
Pulleys/Drive Belts

Motors 11
Motor Controls 12
Brake System 12
Pulleys/Drive Belts 12

Stroboscope Inspection System

Lamps, Controls, Miscellaneous 13

Optional Equipment

Slitting Attachment 14
Splicing Aid 14
Error Detectors 14
Label Counting System 15

Plate Cutters 15

REWIND MACHINES

COREHOLDERS

Mechanical Cam-lock Style (Non Lift-off)

Offered as standard equipment on WT-20's and WT-15 Series Rewind Machines. Also used with air coreholder adapters* allowing cam-lock style coreholders to be used on air inflatable coreholder systems.

Size	P/N
**	*****
1"	32-1002
**	*****
1-1/4"	32-1030
**	*****
1-1/2"	32-1004
1-9/16"	32-1068
1-5/8"	32-1008
1-3/4"	32-1063
1-7/8"	32-1120
2"	32-1005
**	*****
**	*****
2-1/2"	32-1061
2-3/4"	32-1070
3"	32-1001
4"	32-1003
6"	32-1040

Replacement Retainer (WT-15 Series)

Size	P/N
3"	32-1021

Fiber Washer

5/8" x 1/16" 94-2001

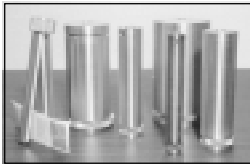

Coreholder Adapter* P/N: 36-1028

(permits use of mechanical cam-lock coreholders on an air inflatable coreholder system)

Lift-off Cam-lock Style

Offered as standard equipment on WT-25 Series Rewind Machines.

Size	P/N
3/4"	32-1144
1"	32-1101
1-3/16"	32-1172
1-1/4"	32-1112
1-3/8"	32-1176
1-1/2"	32-1113
1-9/16"	32-1174
1-5/8"	32-1114
1-3/4"	32-1115
**	*****
2"	32-1102
2-1/8"	32-1127
2-1/4"	32-1137
**	*****
2-3/4"	32-1116
3"	32-1099
4"	32-1104
6"	32-1106

METRIC

32mm	32-1112
40mm	32-1122
42mm	32-1154
45mm	32-1118
50mm	32-1136
70mm	32-1116
120mm	32-1225

Replacement "Cam"

Size	P/N
3/4"	32-1177
1"	32-1138
1-3/16"	32-1170
1-1/4"	32-1169
1-3/8"	32-1175
1-1/2"	32-1139
1-9/16"	32-1153
1-5/8"	32-1140
1-3/4"	32-1173
1-7/8"	32-1179
2"	32-1141
2-1/8"	32-1180
2-1/4"	32-1142
2-1/2"	32-1182
2-3/4"	32-1143
3"	32-1128
4"	32-1133
6"	32-1134

METRIC

32mm	32-1169
40mm	32-1145
42mm	32-1155
45mm	32-1146
50mm	32-1148
70mm	32-1143
120mm	32-1226

Replacement Ball Plunger

for above cams
(2" and larger)
P/N: 75-0308



**CONSULT FACTORY
FOR CUSTOM SIZE
COREHOLDERS**

Removable Mandrels

1"	WT-20/WT-15 Series	P/N: 32-1017 (Includes Clip #32-1050)
1"	WT-25 Series	P/N: 32-1093 (Includes Clip #32-1050)

Coreless Rewind Clips (for above mandrels)

5/8"	P/N: 32-1051 (Use with Coreholder Shaft in lieu of Mandrel)
1"	P/N: 32-1050

Coreholder Adapters (for smaller id coreholders on WT-15 Series Machines)

1/2"	32-1216
3/4"	32-1217

REWIND MACHINES Cont.

COREHOLDERS Cont.

Air Inflatable Style Coreholders

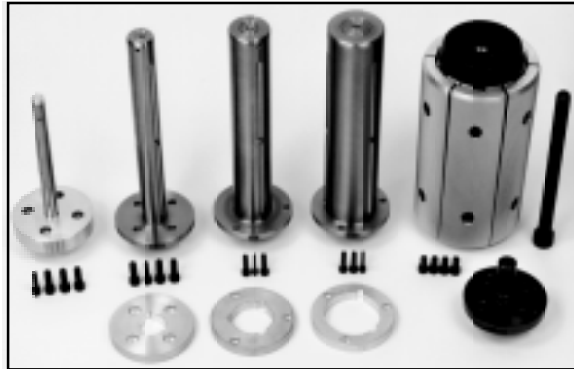

**CONSULT FACTORY
FOR CUSTOM SIZE
COREHOLDERS**

Coreholder

<u>Size</u>	<u>P/N</u>
1/2"	76-6075
7/16"	76-6081
3/4"	76-6063
1"	76-6035
1-1/4"	76-6037
1-5/16"	76-6038
1-1/2"	76-6040
1-5/8"	76-6042
1-3/4"	76-6057
1-7/8"	76-6044
2"	76-6045
2-1/4"	76-6047
2-3/4"	76-6017
3"	76-6001
4"	76-6015
5"	76-6058
6"	76-6056

METRIC

25mm	76-6067
30mm	76-6048
40mm	76-6049
42mm	76-6051
50mm	76-6053
55mm	76-6055
70mm	76-6017
120mm	76-6034

Replacement Retainer

<u>Size</u>	<u>P/N</u>
1/2"	22-1091
7/16"	22-1091
3/4"	22-1086
1"	22-1060
1-1/4"	22-1078
1-5/16"	22-1066
1-1/2"	22-1067
1-5/8"	22-1068
1-3/4"	22-1085
1-7/8"	22-1075
2"	22-1069
2-1/4"	22-1076
Not Applicable	
Not Applicable	
Not Applicable	
Not Applicable	
Not Applicable	

METRIC

25mm	22-1060
30mm	22-1074
40mm	22-1070
42mm	22-1084
50mm	22-1071
55mm	22-1077
Not Applicable	
Not Applicable	

Air Inflatable Coreholder System Components

Air Filter P/N: 89-7001

Air Regulator P/N: 89-7004

 Rotary Union P/N: 77-0501

3-Way Toggle P/N: 83-8001

 Male Elbow P/N: 98-4051



1/8" Close Nipple P/N: 98-4171

REWIND MACHINES Cont.

ELECTRICAL COMPONENTS

Fuses

Main Fuse



115V Machines		
3/4 HP = 10 Amp	P/N: 74-6003	
1 HP = 15 Amp	P/N: 74-6015	
240V Machines		
3/4 HP = 6 Amp	P/N: 74-6013	
1 HP = 8 Amp	P/N: 74-6011	
115V Machines (1-Pole Fuseblock)		
3/4 HP = 12 Amp	P/N: 74-6025	
1 HP = 15 Amp	P/N: 74-6015	
240V Machines (2-Pole Fuseblock)		
3/4 HP = 8 Amp	P/N: 74-6011	
1 HP = 10 Amp	P/N: 74-6003	

KB Motor Control Fuse (see Motors/Motor Controls)

Transformer Fuse

240V Machines Only		
<u>Internal</u>		
2 Amp	P/N: 74-6012	
3 Amp	P/N: 74-6016	
<u>External</u>		
2 Amp	P/N: 74-6012	

Switches

"On/Off" & "Jog" (Toggle)	P/N: 82-1016	
"Forward/Reverse" (Pushbutton Models Only) (Toggle)	P/N: 71-1002	
Main Power (Lighted)	P/N: 75-0201	
"Label/Length" (Toggle)	P/N: 70-6003	
"Print In/Out" (Toggle)	P/N: 82-1025	

Pushbuttons/Contact Blocks

Pushbuttons

Manual Add Pushbutton		
	P/N: 95-7002	
	P/N: 26-1117	

	WT-20	WT-15	WT-15LC	WT-15LCI	WT-25	WT-25LC	WT-25LCI
115V Machines 3/4 HP = 10 Amp	●	●	●	●			
115V Machines 1 HP = 15 Amp	●	●	●	●			
240V Machines 3/4 HP = 6 Amp	●	●	●	●			
240V Machines 1 HP = 8 Amp	●	●	●	●			
115V Machines (1-Pole Fuseblock) 3/4 HP = 12 Amp					●	●	●
115V Machines (1-Pole Fuseblock) 1 HP = 15 Amp					●	●	●
240V Machines (2-Pole Fuseblock) 3/4 HP = 8 Amp					●	●	●
240V Machines (2-Pole Fuseblock) 1 HP = 10 Amp					●	●	●
KB Motor Control Fuse							
Transformer Fuse Internal 2 Amp		●	●		●	●	
Transformer Fuse Internal 3 Amp				●			●
Transformer Fuse External 2 Amp					●	●	●
"On/Off" & "Jog" (Toggle)	●	●	●	●	●	●	●
"Forward/Reverse" (Pushbutton Models Only) (Toggle)	●	●	●	●			
Main Power (Lighted)					●	●	●
"Label/Length" (Toggle)			●	●			
"Print In/Out" (Toggle)		●			●	●	●
Manual Add Pushbutton			●	●			●
						●	●

REWIND MACHINES Cont.

ELECTRICAL COMPONENTS Cont.

Pushbuttons/Contact Blocks Cont

Pushbuttons Cont.

Start (Green) Pushbutton

P/N: 71-1004



P/N: 84-1503



Stop (Red) Pushbutton

P/N: 71-1001

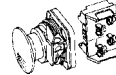

P/N: 84-1502



Anti-Rotation Ring for P/N 84-1502 & 84-1503 Pushbuttons

P/N: 84-1504

Contact Blocks

1 NC

P/N: 84-1505



1 NO

P/N: 84-1506



Relays/Relay Sockets

Relays

4 PDT (Clear)

P/N: 82-4001

Main Circuit Board (WT-20's & WT-25 Series)

Main Circuit Board (WT-15 Series/KB Motor Control Retrofit)

Counter Package (WT-15 Series LC/LCI's)



2 PDT (Clear)

P/N: 82-4004

Main Circuit Board (WT-20's & WT-25 Series)

Main Circuit Board (WT-15 Series/KB Motor Control Retrofit)

Counter Package (WT-15 Series LC/LCI's)



2 PDT (Blue)

P/N: 82-4008

Main Circuit Board (WT-20's & WT-15 Series)



Time Delay

Artisan Time Capsule

P/N: 26-1252



	WT-20	WT-15	WT-15LC	WT-15LCI	WT-25	WT-25LC	WT-25LCI
Start (Green) Pushbutton P/N: 71-1004	•	•	•	•			
Start (Green) Pushbutton P/N: 84-1503					•	•	•
Stop (Red) Pushbutton P/N: 71-1001	•	•	•	•			
Stop (Red) Pushbutton P/N: 84-1502					•	•	•
Anti-Rotation Ring for P/N 84-1502 & 84-1503 Pushbuttons P/N: 84-1504					•	•	•
1 NC P/N: 84-1505					•	•	•
1 NO P/N: 84-1506					•	•	•
4 PDT (Clear) P/N: 82-4001	•				•	•	•
2 PDT (Clear) P/N: 82-4004	•				•	•	•
2 PDT (Blue) P/N: 82-4008	•	•	•	•			
Artisan Time Capsule P/N: 26-1252	•	•	•	•			

REWIND MACHINES Cont.

ELECTRICAL COMPONENTS Cont.

Potentiometers/Knobs

Potentiometers

Main Speed

Footswitch Models

115V 500K P/N: 86-3002



240V 5K P/N: 86-3003



Pushbutton Models

Machines with original Danfoss Motor Control

115V 500K P/N: 26-1056*



240V 5K P/N: 26-1061*

*Will come pre-assembled with wiring/connector

Machines with KB Motor Control (Retrofit or Original)

10K P/N: 26-1091



Idle Speed

2K P/N: 26-1090
(Machines without #01-1117 Main Circuit Board)



2K P/N: 26-1135
(Machines with #01-1117 Main Circuit Board)



Sensitivity/Counter Package

10 Turn 100K P/N: 71-1504



Knobs (for Potentiometers)

Speed Potentiometers P/N: 46-1017
(see above P/N's 26-1090,26-1091 & 26-1135)



Sensitivity Potentiometer P/N: 76-5004
(see above P/N 71-1504)



Sensitivity Potentiometer P/N: 46-1014
(not shown above)

Lamps

Power Indicator P/N: 77-1001



	WT-20	WT-15	WT-15LC	WT-15LCI	WT-25	WT-25LC	WT-25LCI
115V 500K Footswitch		•					
240V 5K Footswitch		•					
115V 500K Pushbutton		•	•	•			
240V 5K Pushbutton		•	•	•			
10K Pushbutton		•	•	•	•	•	•
2K Pushbutton (no #01-1117)					•	•	•
2K Pushbutton (#01-1117)					•	•	•
10 Turn 100K			•	•			
Speed Potentiometer Knob		•	•	•	•	•	•
Sensitivity Potentiometer Knob			•	•			
Sensitivity Potentiometer (not shown)						•	•
Power Indicator Lamp	•	•	•	•			

REWIND MACHINES Cont.

ELECTRICAL COMPONENTS Cont.

Circuit Boards

Main Circuit Board

Footswitch Models

115V P/N: 26-1029
240V P/N: 02-1077

Pushbutton Models

115V (WT-20) P/N: 26-1019
115V (WT-15 Series) P/N: 02-1002
115V/240V (WT-25 Series) P/N: 01-1117
240V (WT-15 Series) P/N: 02-1049
115V/240V P/N: 01-1129
(WT-25 Series w/Constant Web Speed)

Counter/Photo-Electric Counter Circuit Board

Photo-Electric Counter Interface P/N: 26-1044
Counter P/N: 01-1107
Counter P/N: 01-1113

FOOTSWITCH REPLACEMENT KIT

115V P/N: 26-1209
220V P/N: 26-1210
Troubleshooting Kit P/N: 26-1181

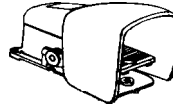

MISCELLANEOUS

Tape Dispenser P/N: 96-1001
Operator's Manual P/N: MANUAL

	WT-20	WT-15	WT-15LC	WT-15LCI	WT-25	WT-25LC	WT-25LCI
Footswitch Models		•					
Pushbutton Models	•	•					
115V (WT-20)		•					
115V (WT-15 Series)		•	•	•			
115V/240V (WT-25 Series)		•	•	•	•	•	•
240V (WT-15 Series)		•	•	•			
115V/240V (WT-25 Series w/Constant Web Speed)					•	•	•
Counter/Photo-Electric Counter Circuit Board			•	•			
Photo-Electric Counter Interface					•		•
Counter						•	•
Footswitch Replacement Kit		•					
Troubleshooting Kit		•					
Miscellaneous							
Tape Dispenser	•	•	•	•	•	•	•
Operator's Manual	•	•	•	•	•	•	•

REWIND MACHINES Cont.

COUNTING SYSTEM (COUNTERS, SWITCHES, THRU-BEAM SCANNERS)

Counters

Veeder-Root (no longer available - Replace with Durant)

Durant 6-Digit (2 Level LCD) P/N: 77-8803



ATC

354 5VDC Pulse P/N: 72-6002



356 120VAC Pulse P/N: 72-6001

Spare Parts for ATC Counters:

Cover Plate P/N: 72-6003

Overlay P/N: 72-6004

Gasket P/N: 72-6005

Stud & Cap P/N: 72-6006

(Set of 2)
Housing P/N: 72-6007

KEP

Dual Preset P/N: 85-1302

Dual Preset (includes wiring harness) P/N: 26-1175

Dual Preset w/RS-232 Serial P/N: 85-1303

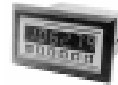

Spare Parts for KEP Counters:

Minitrol Case P/N: 85-1305

Faceplate P/N: 85-1304

Miscellaneous

Replacement Counter Pkg P/N: 01-1022

Label Counting System (see Optional Equipment)

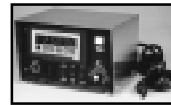

Switches

Proximity Switches

Reed Switch Replacement Kit P/N: 26-1058



Reed Switch Assembly P/N: 26-1101
(assembly includes terminal connector not shown)



Reed Switch w/Long Leads P/N: 82-7102
(no terminal connector provided)

Hall Effect Switch* P/N: 26-1202
(assembly includes terminal connector not shown)



Hall Effect Switch* w/Long Leads P/N: 26-1203
(no terminal connector provided)

	WT-20	WT-15	WT-15LC	WT-15LCI	WT-25	WT-25LC	WT-25LCI
Durant 6-Digit (2 Level LCD)	●	●	●	●			
ATC 354 5VDC Pulse			●	●			
ATC 356 120VAC Pulse	●	●					
KEP Dual Preset							
KEP Dual Preset (includes wiring harness)					●		
KEP Dual Preset w/RS-232 Serial					●	●	●
Replacement Counter Pkg			●	●			
Reed Switch Replacement Kit	●	●	●	●			
Reed Switch Assembly					●	●	●
Reed Switch w/Long Leads					●	●	●
Hall Effect Switch*					●	●	●
Hall Effect Switch* w/Long Leads					●	●	●

*(Rewind Machines must be equipped with P/N 01-1113 Revision D (or later) OR P/N 01-1107 Revision E (or later) Counter Circuit Board. Machines with earlier revisions can be retrofitted to use Hall Effect Switches. Please consult factory for more information.)

REWIND MACHINES Cont.

COUNTING SYSTEM (COUNTERS, SWITCHES, THRU-BEAM SCANNERS) Cont.

Switches Cont.

Counter Reset

Wiring/Connector
Included
(not shown)

P/N: 26-1057



P/N: 26-1067



Scanners

Thru-Beam

Scanner Modification Kit
(to replace Skan-A-Matic components
with Web Techniques components)

Infrared

P/N: 26-1169

P/N: 26-1170

Visible Red

P/N: 26-1198

P/N: 26-1199

Light Source

Infrared

P/N: 26-1163

Visible Red

P/N: 26-1197

Photocell

P/N: 26-1164

Cable & Plug Assembly

P/N: 26-1168

P/N: 26-1165

Model S-10 Scanner

10"

P/N: 01-1144

10"

P/N: 01-1137

Model S-12 Scanner (required for use of 12" or Metric Counter Drive Roll)

12"

P/N: 01-1138

Label Edge Detection System

LRD2100 (includes mounting bracket)
Cable Adapter
(required to use LRD2100 on WT-15LC/LCI's)

P/N: 01-1156

P/N: 02-1237



Reflective

Universal

P/N: 01V1010

P/N: 01V1106

Black

P/N: 01K1010

Blue

P/N: 01B1010

Red

P/N: 01R1010

	WT-20	WT-15	WT-15LC	WT-15LCI	WT-25	WT-25LC	WT-25LCI
Counter Reset (P/N: 26-1057)	●	●					
Counter Reset (P/N: 26-1067)			●	●			
Scanner Modification Kit (Infrared)			●	●			
Scanner Modification Kit (Visible Red)						●	●
Scanner Modification Kit (Light Source Infrared)			●	●			
Scanner Modification Kit (Light Source Visible Red)			●	●		●	●
Scanner Modification Kit (Photocell)			●	●		●	●
Scanner Modification Kit (Cable & Plug Assembly)			●	●		●	●
Scanner Modification Kit (Model S-10 Scanner 10")			●	●			
Scanner Modification Kit (Model S-10 Scanner 10")						●	●
Scanner Modification Kit (Model S-12 Scanner 12")						●	●
Label Edge Detection System (LRD2100)			●	●		●	●
Label Edge Detection System (Cable Adapter)			●	●			
Reflective (Universal)			●	●			
Reflective (Black)			●	●		●	●
Reflective (Blue)			●	●			
Reflective (Red)			●	●			

REWIND MACHINES Cont.

IDLER ROLLS, CLAMPS, CARTRIDGES, BEARINGS, SHAFTS/FLANGES

Idler Rolls

3" OD x 7"L x 3/4" ID P/N: 31-1002
 Recessed Idler Roll Module P/N: 02-1192
 Fiber Washer (3/4" x 1/32") P/N: 94-2002

Collar Clamps

Idler Roll P/N: 83-3012
 (3/4" ID - Non-Threaded)
 Unwind/Rewind Shaft P/N: 83-3013
 (Lower Clamp - Threaded) (3/4" - 16)
 Unwind/Rewind Shaft P/N: 83-3025
 (Upper Clamp - Non-Threaded) (25mm)



Cartridges

Idler Roll Shaft P/N: 33-1003
 P/N: 33-1019
 Counter Drive Roll Shaft P/N: 33-1020

Bearings

Idler Roll P/N: 82-1001
 3/4" ID
 Bronze, Flanged 1/2" x 5/8" P/N: 73-5007
 (For Slitting Attachment)
 Unwind/Rewind Shaft
 ER-10K (Cam-Lock) (5/8" ID) P/N: 87-3001
 ER-16K (Air) (1" ID) P/N: 87-3002
 Ball (25mm ID) P/N: 80-1003



Shafts/Flanges

Unwind-Rewind w/Flats P/N: 36-1003
 w/o Flats P/N: 36-1029
 Air Coreholder P/N: 36-1069
 Lift-off Coreholder P/N: 36-1068

	WT-20	WT-15	WT-15LC	WT-15LCI	WT-25	WT-25LC	WT-25LCI
3" OD x 7"L x 3/4" ID	●	●	●	●	●	●	●
Recessed Idler Roll Module	●	●	●	●	●	●	●
Fiber Washer (3/4" x 1/32")	●	●	●	●	●	●	●
Idler Roll (3/4" ID - Non-Threaded)	●	●	●	●	●	●	●
Unwind/Rewind Shaft (Lower Clamp - Threaded) (3/4" - 16)					●	●	●
Unwind/Rewind Shaft (Upper Clamp - Non-Threaded) (25mm)					●	●	●
Idler Roll Shaft	●	●	●	●			
Counter Drive Roll Shaft					●	●	●
Idler Roll 3/4" ID	●	●	●	●	●	●	●
Bronze, Flanged 1/2" x 5/8" (For Slitting Attachment)	●	●	●	●	●	●	●
ER-10K (Cam-Lock) (5/8" ID)	●	●	●	●			
ER-16K (Air) (1" ID)	●	●	●	●			
Ball (25mm ID)					●	●	●
Unwind-Rewind w/Flats	●	●	●	●			
Unwind-Rewind w/o Flats	●	●	●	●			
Air Coreholder					●	●	●
Lift-off Coreholder					●	●	●

REWIND MACHINES Cont.

MOTORS, MOTOR CONTROLS, BRAKE SYSTEM, PULLEYS & BELTS Cont.

Motor Controls Cont.

KB Cont.

Resistors for KB Motor Controls

- 115V Machines
 - 3/4 HP 90 VDC P/N: 85-1202
 - 1 HP 90 VDC P/N: 85-1203
- 240V Machines
 - 3/4 HP 180 VDC P/N: 85-1206
 - 1 HP 180 VDC P/N: 85-1205

Fuses for KB Motor Controls

- Line Fuse (25 Amp) P/N: 74-6020
- Armature Fuse
 - 115V Machines
 - 3/4 HP 90 VDC (12 Amp) P/N: 74-6017
 - 1 HP 90 VDC (15 Amp) P/N: 74-6021
 - 240V Machines
 - 3/4 HP 90 VDC (6 Amp) P/N: 74-6026
 - 1 HP 90 VDC (8 Amp) P/N: 74-6027



Brake System

- Unwind Brake (Pulley or Drum) P/N: 74-1009
P/N: 22-1063
- Brake Band P/N: 59-1017
- Brake Band Block P/N: 24-1054
- Brake Compression Spring P/N: 86-2101
- Brake Adj. Screw Assy P/N: 59-1004

Pulleys/Drive Belts

- V-Belt Pulley (Standard Speed)
 - Taperlock P/N: 74-1002
 - Non-Taperlock P/N: 74-1038

Taperlock Bushing for above V-Belt

- H X 1" - Air Coreholder P/N: 74-1026
- H x 5/8" - Cam-lock Coreholder P/N: 74-1003

- V-Belt Pulley (Increased Speed)
 - Taperlock P/N: 74-1024
 - Non-Taperlock P/N: 74-1039

- V-Belt Pulley (Motor) P/N: 74-1037

- Drive Belt (Standard Speed) P/N: 59-1081
- Drive Belt (Increased Speed) P/N: 59-1082



	WT-20	WT-15	WT-15LC	WT-15LCI	WT-25	WT-25LC	WT-25LCI
Resistor 115V 3/4 HP 90 VDC	●	●	●	●	●	●	●
Resistor 115V 1 HP 90 VDC	●	●	●	●	●	●	●
Resistor 240V 3/4 HP 180 VDC	●	●	●	●	●	●	●
Resistor 240V 1 HP 180 VDC	●	●	●	●	●	●	●
Line Fuse (25 Amp)	●	●	●	●	●	●	●
Armature Fuse 115V 3/4 HP 90 VDC (12 Amp)	●	●	●	●	●	●	●
Armature Fuse 115V 1 HP 90 VDC (15 Amp)	●	●	●	●	●	●	●
Armature Fuse 240V 3/4 HP 90 VDC (6 Amp)	●	●	●	●	●	●	●
Armature Fuse 240V 1 HP 90 VDC (8 Amp)	●	●	●	●	●	●	●
Unwind Brake (Pulley or Drum)		●	●	●	●	●	●
Brake Band		●	●	●	●	●	●
Brake Band Block		●	●	●	●	●	●
Brake Compression Spring		●	●	●	●	●	●
Brake Adj. Screw Assy		●	●	●	●	●	●
V-Belt Pulley (Standard Speed) Taperlock	●	●	●	●			
V-Belt Pulley (Standard Speed) Non-Taperlock		●	●	●	●	●	●
Taperlock Bushing H X 1" - Air Coreholder	●	●	●	●			
Taperlock Bushing H x 5/8" - Cam-lock Coreholder	●	●	●	●			
V-Belt Pulley (Increased Speed) Taperlock	●	●	●	●			
V-Belt Pulley (Increased Speed) Non-Taperlock		●	●	●	●	●	●
V-Belt Pulley (Motor)	●	●	●	●	●	●	●
Drive Belt (Standard Speed)	●	●	●	●	●	●	●
Drive Belt (Increased Speed)	●	●	●	●	●	●	●

STROBOSCOPE INSPECTION SYSTEM

Strobe Lamps/Strobe Controls

Note: Original Ametek and AMR Stroboscope Inspection Systems are no longer supported by Web Techniques, Inc. Please consult original manufacturer(s) for service and parts for these strobe systems or consult Web Techniques for information on replacing the parts with a Web Techniques strobe inspection system.

Lamps

SB-10 Strobe Lamp (refer to SB-11 Lamp)

SB-11 Strobe Lamp

P/N: 01-1171

Replacement Strobe Flash Tube

(Ametek/AMR/Web Techniques Strobe Lamps)

P/N: 90-9003

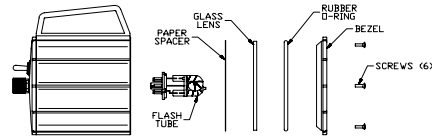

Replacement Parts for SB-10/SB-11 Strobe Lamps

① Clear Lens	P/N: 59-1124
② Backplate	P/N: 59-1125
③ Arm Assembly w/Joints	P/N: 59-1111
④ Joint Fastener	P/N: 59-1112
⑤ Base	P/N: 59-1110
- Circuit Board	P/N: 01-1130
⑥ Front Plate	P/N: 59-1126
- Cable Assy	
SB-10	P/N: 26-1151
SB-11	P/N: 26-1212
- O-Ring	P/N: 59-1127
- Female Terminal	P/N: 74-5602
- Bushing	P/N: 71-4105

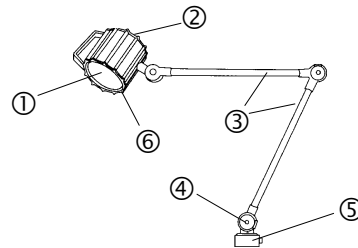

Model SB-10/SB-11 Strobe Lamp

Controls

SB-20 Strobe Control (refer to SB-22 Control)

SB-21 Strobe Control (refer to SB-22 Control)

SB-22 Strobe Control

115V

P/N: 01-1158

240V

P/N: 01-1159

Receptacle, 3 Pin DIN

P/N: 46-1029

Synchronization Cable Adapters

Adapter, Amphenol to DIN (WT-15/25)

P/N: 26-1179

Adapter, SB-10 to SB-22

P/N: 26-1229

Adapter, SB-11 to SB-21

P/N: 26-1230

Trigger Cables

(Required to trigger/chain two or more SB-22 Strobe Control Units)

6 Foot

P/N: 26-1224

18 Foot

P/N: 26-1225

Mounting Hardware

Strobe Control Mounting Bracket P/N: 20-1180

Strobe Lamp Mounting Base & Hardware P/N: 59-1115

Strobe Lamp Mounting Adaptors:

Pin Adaptor P/N: 59-1101

Clamp Bracket P/N: 59-1099

Wall Bracket P/N: 59-1100

Miscellaneous Strobe Equipment

SB-3 Manual Flash Rate Control (SB-21) P/N: 26-1183

Photo-Electric Synchronization System P/N: 02-1248

Synchronization Cables

Counter to AMR Strobe (WT-15) P/N: 26-1039

Counter to AMR Strobe (WT-25) P/N: 26-1112

Counter to SB-XX Strobe (WT-25) P/N: 26-1167

SB-1 Gear Driven Strobe

P/N: 02-1202

Synchronization Kit



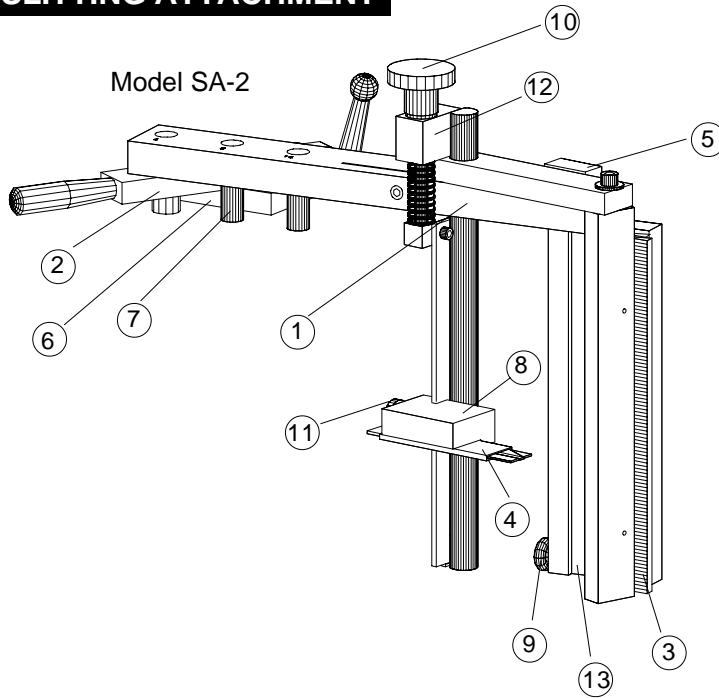

OPTIONAL EQUIPMENT

SLITTING ATTACHMENT



Description	P/N
1 Arm	24-1169
2 Arm, Double Jointed (available for Model SA-2 only)	24-1200
3 Brush	59-1043
4 Carton Cutter w/Blade	59-1044
5 Magnet Catch	59-1156
6 Mounting Block, Double Jointed (SA-2 Only)	24-1199
7 Pin (Pivot)	59-1050
8 Razor Blade Holder, 3/4" Razor Blade Holder, 1/4" (not shown)	59-1046 59-1045
Razor Blades (Box of 100) (not shown)	82-1060
9 Roller, 3/4" Dia w/Bearing	59-1042
Screw, Maget Catch (not shown)	6100404
10 Steel Knob, Knurled (1 of 2)	92-8017
10 Screw, Vertical Adj (2 of 2)	59-1049
11 Thumbscrew (3/4" wide razor blade holders only)	59-1102
12 Block, Vertical Adjustment	24-1174
13 Rule, 1/2" Wide	59-1047

SPLICING AID

	Dowel Pin, 3/16 x 5/8	59-1134
	Eyebolt	75-0303
	Nut, Hex 1/4-20	6502500
	Plate	24-1080
	Cam (Handle)	75-0305



Spring Washer, 1/4	59-1025
Spring, Compression	86-2102
Clamp Block, Top	24-1082
Washer, Spherical	75-0304



ERROR DETECTORS (MODEL ERR-10 AND MODEL ERR-12)

Power Supply, 5VDC	26-1223	Encoder, 60 PPR	77-9508
Bracket, Pivot Mounting	24-1144	Cartridge, Pivot Shaft	33-1013
Circuit Board (ERR-12 Only)	02-1072		

OPTIONAL EQUIPMENT

LABEL COUNTING SYSTEM



Replacement Counter:

KEP P/N: 85-1302

KEP RS-232 P/N: 85-1303

Sensitivity P/N: 46-1014

Knob

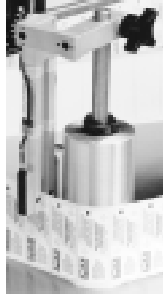

Replacement Scanners & Scanner Parts:

See pg. 9 under Rewind Machines.



PLATE CUTTERS

① Knife Blade

Model WT-1 P/N: 24-1006

Model WT-2 P/N: 24-1039

Packing Board, Knife Blade

Model WT-1 P/N: 18-2010

Model WT-2 P/N: 18-2011

Resharpening Service Available

② Cutting Sticks (Package of 6)

Model WT-1 P/N: 75-0501

Model WT-2 P/N: 75-0502

③ Label, Grid Plate P/N: 09-1021

④ Work Lamp P/N: 89-3501

Floor Stand

Model WT-1 P/N: 01-1030

Model WT-2 P/N: 01-1031

